



Retrofit Light Bar

Integrated T8 LED Tube

DESCRIPTION

Reimagining indoor linear lighting, the Retrofit Light Bar combines unique aesthetics with exceptional optical performance. Offered with wattage and color temperature selectable, Two wattage package options are available in 10W/15W/20W or 22W/30W/40W, while the color temperature ranges from 3500K, 4000K, 5000K, 5700K, to 6500K. This flexibility makes it suitable for a wide range of lighting applications. Perfect for enhancing any commercial space. Available in a 2ft or 4ft lengths.

APPLICATION

Perfect for a wide range of indoor environments, including offices, schools, hospitals, hotels, supermarkets, warehouses, parking garages, and other indoor lighting needs. Designed for exceptional performance, this fixture enhances any space with its reliable illumination.

LENGTH

The retrofit light bar is available in two lengths: 22.5" and 45".

FEATURES

- Max Run Wattage
- CRI options 80+
- Beam Angle: 120°
- Single/Double-Ended Wiring available
- AC 120-277V, 50/60Hz

CONSTRUCTION

Extruded aluminum housing with clear/frosted lens cover. Operating temperature range: -20° C to 60° C.

MOUNTING

Available in a Surface Mount. Mounting hardware included: Brackets (2), Screws

WARRANTY

5 year warranty standard, Optional 10 year warranty available upon request.

SAFETY NOTE

Do not connect more than 600W(add up) at 120VAC. Do not connect more than 1200W(add up) at 277VAC.

LISTINGS/COMPLIANCE

- ETL - Listed IP44
- DLC

*IES Files available upon request or visit vivid-forms.com

ORDERING INFORMATION

Series	Length	Wattage	Voltage	Color temperature	Lens	Finish	Mounting

Series	Length	Wattage	Voltage	Color temperature	Lens	Mounting
RL Retrofit Light Bar	2 - 2ft 4 - 4ft	WS1 - Wattage Selectable 10W/15W/20W WS2 - Wattage Selectable 22W/30W/40W	UNV - 120-277V	5CCTA - 3500K/ 4000K/ 5000K/ 5700K/ 6500K Wall Switch Tunable	C - Clear F - Frosted	SM - Surface Mount

DIMENSION

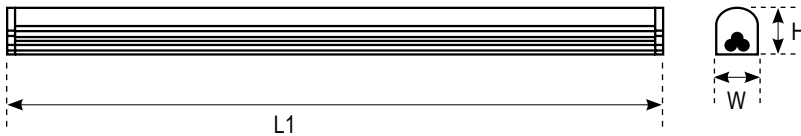

Size	L1 Length	W=Width	H=Height
2'	22.5"	1.18"	1.42"
4'	45"		

WALL SWITCH INSTRUCTION



When you switch to the **“wall switch”** mode, the **CCT starts at 5000K**. Toggling the wall switch **“off-on within 1 second”** will cycle the CCT sequentially through **“5000K → 5700K → 6500K → 3500K → 4000K”** with each switch.

If the light remains **“on for more than 10 seconds”**, the **“current CCT will be automatically memorized”** and will start at the same setting the next time it is turned on.

If the memorized CCT appears inconsistent after installation, it can be adjusted using the **“reset”** function. Simply toggle the wall switch **“off-on twice within 1 second”**, and all lamps will reset to **“5000K”**, allowing for synchronized adjustments.

INSTALLATION

1. Standard accessories included as below:

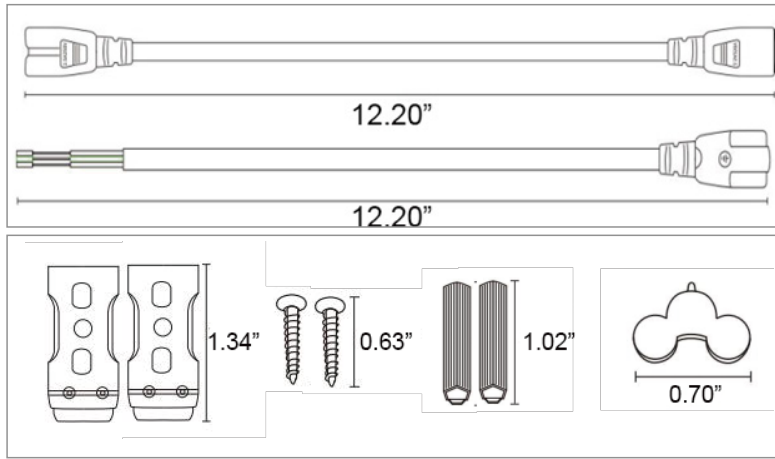

2. Installation instruction:

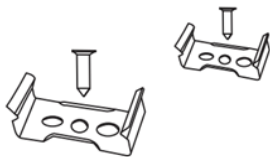

1. Verify the position of the brackets on the wall.

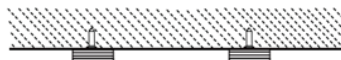

2. Secure the bracket to the wall with screws.

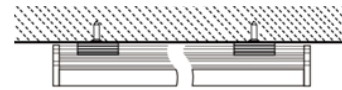

3. Attach the light securely to the bracket.

3. Connection instruction:

Method 1: Connector

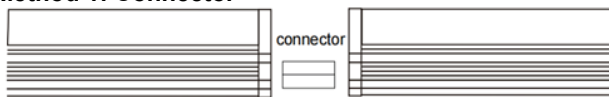

1. Locate the connector in the accessories bag.

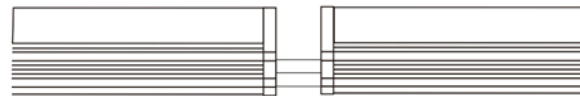

2. Insert the connector into the tube.

Method 2: Middle Connector

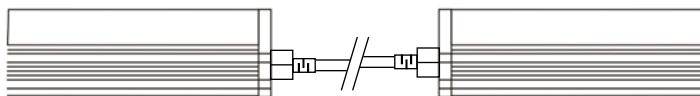

1. Please find the middle connector, plug the middle connector into the tube

For safety standard, in a row please:
Do not connect more than 600W(add up) at 120VAC.
Do not connect more than 1200W(add up) at 277VAC.